

# Visible Burr



*Designed by Bill Cutler 1978, made by J. McFarland 2012.  
(24 Maple, Walnut, and Cherry 3/4" rods, 5.25" square assembled)*

*Copyright J. A. Storer*

**Visible Burr Solution Page 0**  
 (copyright by and courtesy of Bill Cutler)

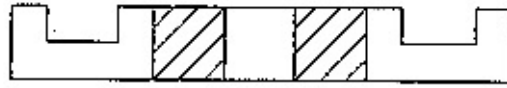

12 pieces - 4 of each wood

**Assembly Instructions:**

- 1) Assemble 12 identical pieces
- 2) Add pieces numbered 1-12 in numerical order

**Disassembly:**

Piece #12 is first to come out, followed by #11, #10, etc.

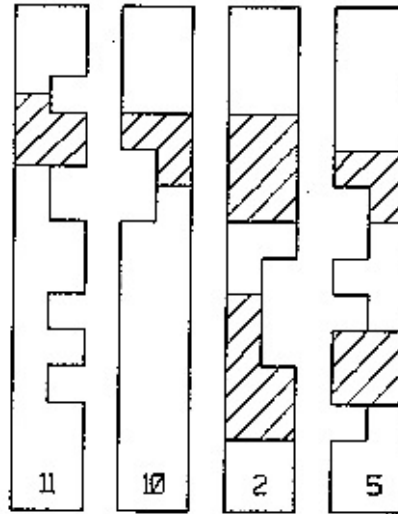

Cherry (top-bottom)

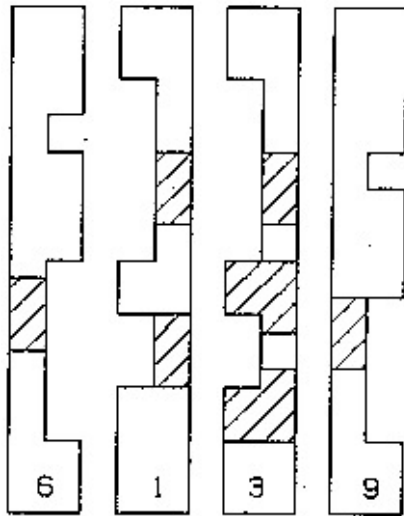

Maple (up-down)

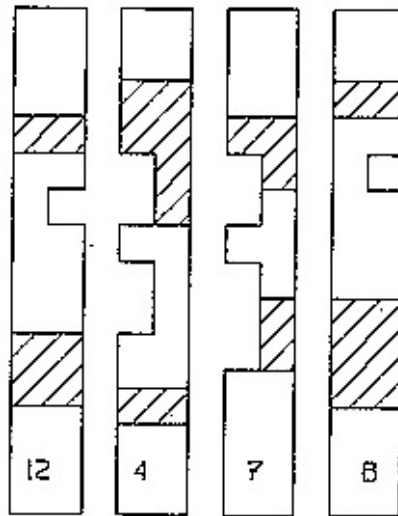

Walnut (left-right)

Copyright 1978 Bill Cutler Puzzles, Inc. All rights reserved.

**Visible Burr Solution Page 1**  
 (copyright by and courtesy of Bill Cutler)

Visible Burr - Layers - Page 1

Top

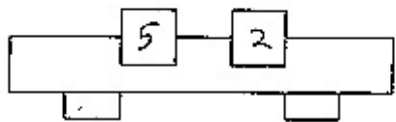
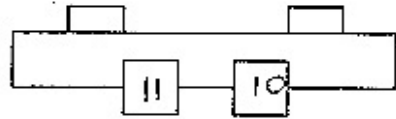

Layer 2

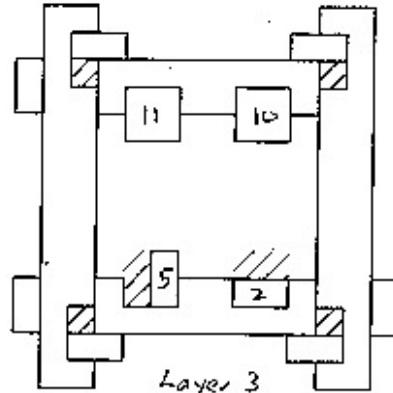

Layer 3

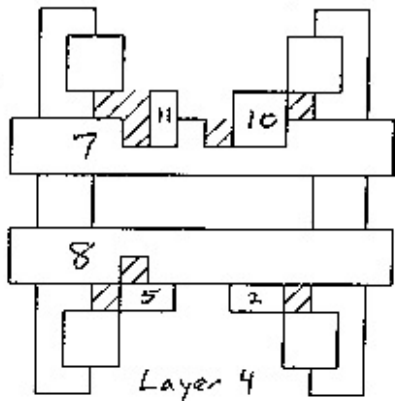

Layer 4

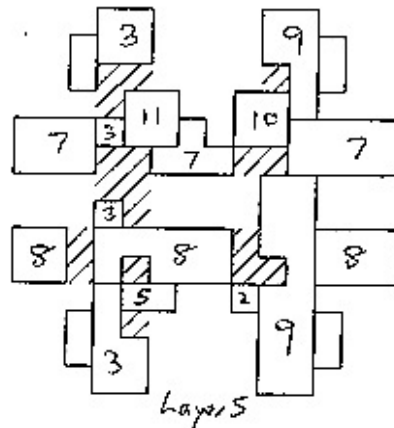

Layer 5

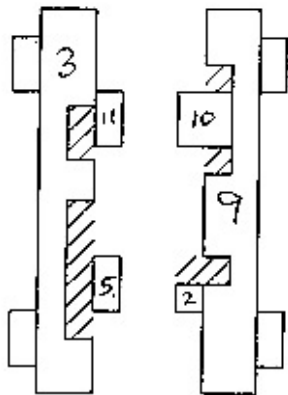

Layer 6

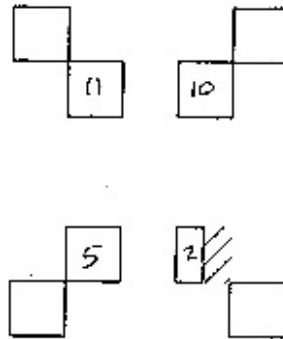

Layer 7

Layers 1 and 14 same as Layer 7 with no holes

**Visible Burr Solution Page 2**  
 (copyright by and courtesy of Bill Cutler)

Visible Burr - Layers - Page 2

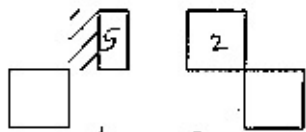
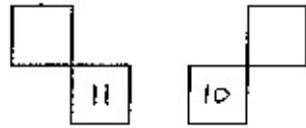

Layer 8

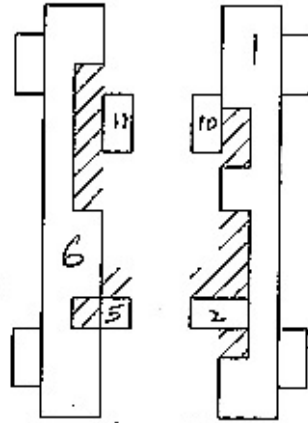

Layer 9

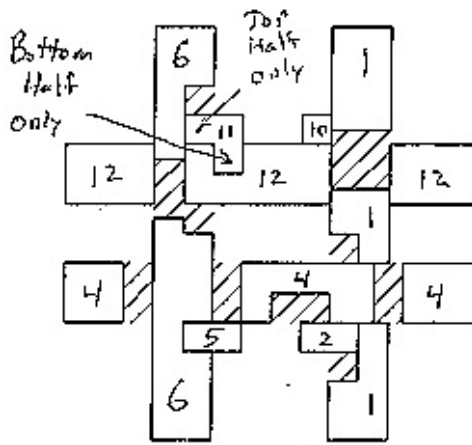

Layer 10

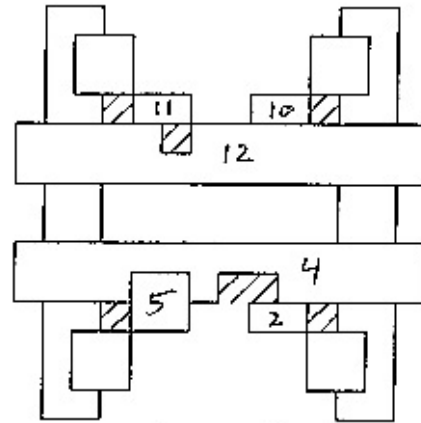

Layer 11

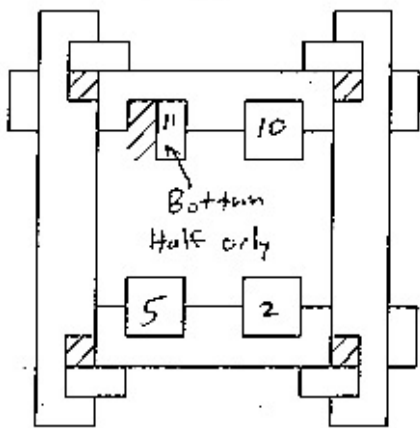

Layer 12

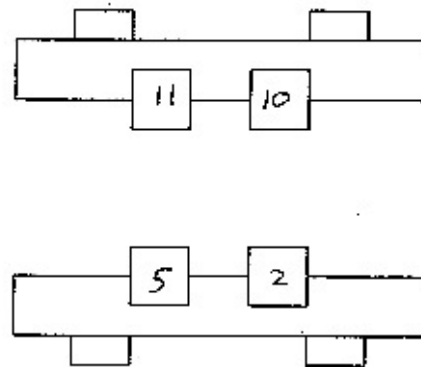

Layer 13